

EASY WASH 50E

esempio di installazione libera

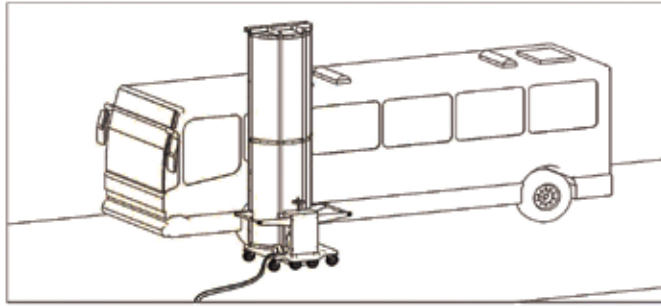

esempio di installazione con tralicci portanti

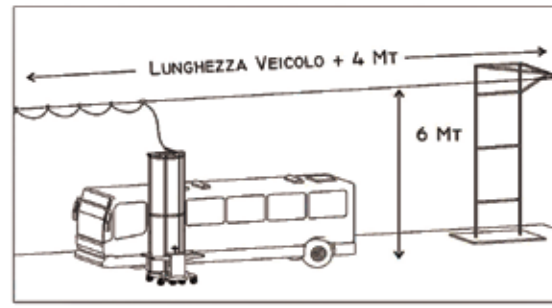

esempio di installazione con mensole portanti

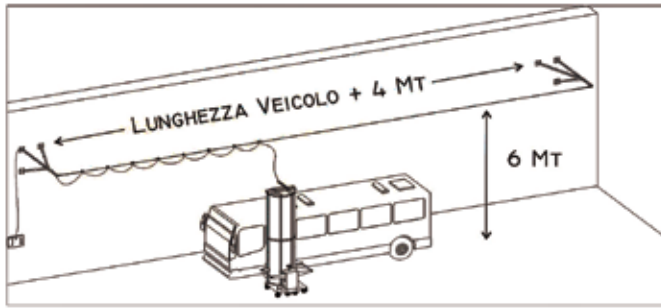

esempio di installazione in locale chiuso

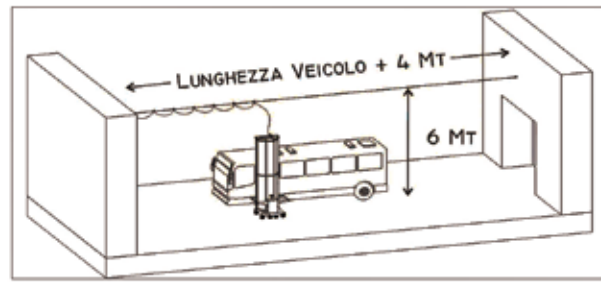

Il sistema di lavaggio per veicoli industriali pratico, veloce ed economico.

The convenient, quick, economical way of washing commercial vehicles.



DATI TECNICI	MOD. 50E
UTILIZZO	AUTOCARRI, BUS
ALTEZZA COMPLESSIVA mm	4300
ALTEZZA LAVAGGIO UTILE mm	4200
DIAMETRO SPAZZOLA mm	1000
PIASTA DI BASE mm	1110x1200
PESO Kg	220
MOTORE SPAZZOLA Kw	1.5
INCLINAZIONE SPAZZOLA	MANUALE
ALLACCIAMENTO ELETTRICO	220/230 V- 16A
ALLACCIAMENTO IDRICO	1/2" o 3/4"
PRESSIONE ACQUA	4/5 atm
PORTATA ACQUA	20/30 lt/min

TECHINCAL DATA	MOD. 50E
USE	TRUCKS, BUS
TOTAL HEIGHT mm	4300
USEFUL WASHING HEIGHT mm	4200
BRUSH DIAMETER mm	1000
BASE PLATE mm	1110x1200
WEIGHT Kg	220
BRUSH MOTOR Kw	1.5
BRUSH INCLINATION	MANUAL
ELECTRICAL CONNECTION	220/230 V- 16A
WATER CONNECTION	1/2" o 3/4"
WATER PRESSURE	4/5 atm
WATER FLOW RATE	20/30 lt/min

EASYWASH 50E, può essere velocemente installato in 2 modi:
 1) con allacciamento diretto, i cavi di alimentazione sono liberi al suolo, ed è utilizzabile ovunque.

2) con allacciamento aereo in un luogo fisso per il lavaggio.

CARATTERISTICHE TECNICHE:

- Dispositivo di inclinazione della spazzola per il lavaggio dei frontali inclinati.
- Carrello a sei ruote, due delle quali direzionali e montate su assale regolabile. Ciò assicura l'aderenza al terreno e il recupero del consumo delle gomme, a garanzia di un avanzamento parallelo del veicolo da lavare.
- Impianto elettrico a 24 Volt sui comandi.
- Barra porta ugelli regolabili, con ugelli spruzzatori a getto piatto.

Per il modello BUS sono disponibili 3 modelli di spazzole a scelta:

- 1) Spazzola con filo in polietilene (MODELLO STANDARD)
- 2) Spazzola con filo misto carlite (MODELLO DELICATO)
- 3) Spazzola speciale in carlite per la massima protezione della vernice (ESCLUSIVA ITECO)

EASYWASH 50E, can be rapidly installed in two ways:

1) by direct connection. Cables and hoses are connected on the back of the machine without any driving system and the machine can be used anywhere.

2) with overhead rail installation in a fixed place dedicated to the cleaning service.

TECHNICAL FEATURES:

- Tilting facility for the brush to clean sloping surfaces.
- Six wheeled trolley, two directional wheels installed on an adjustable axle. This ensures ground grip and less wear but mostly ensures the parallel movement alongside the vehicle to be washed.
- Control panel 24V - Waterproof bearings . Adjustable nozzle bar - Flat spray nozzles.

There is a choice of three different type of brushes:

- 1) Polyethylene (STANDARD MODEL)
- 2) Mixed carlite-poly (SOFT DELICATE MODEL)
- 3) CARLITE brush for maximum body protection and polishing (ITECO EXCLUSIVE)

ITECO s.r.l.
 Via Grande, 15 - 42028 Poviglio (RE) - Italy
 tel. +39 0522 969610 - fax +39 0522 960583
 www.itecosrl.com - e-mail: info@itecosrl.com

iteco[®]
 WASHING SYSTEMS

Quality made in Italy

since 1983





 Praticità, alte prestazioni e bassi costi: sono i punti di forza di EASYWASH 50.

Manovrabile senza fatica da una persona, può lavare un autoarticolato in meno di 10 minuti con consumi di acqua e di energia elettrica minimi.

 Convenience, high performance and low costs: these are the strengths of EASYWASH 50.

Maneuverable without any difficulty by only one operator, the E50 can wash a tractor-trailer in less than 10 minutes with low consumption of electricity and water

 Potenza e delicatezza nel rispetto delle superfici delicate. Disponibile con differenti tipi di spazzole:

- spazzola in polietilene
- spazzola con filo misto
- spazzola in carlite

 Power and sensitivity respecting delicate surfaces. Available with different types of brushes:

- polyethylene brush
- mixed brush
- carlite brush



pulsante di avviamento 24 volt
starter button 24 volt



maniglione di guida
driving and control handle



volantino per l'inclinazione
tilting steering wheel

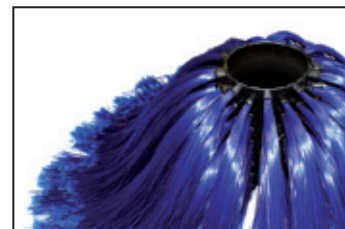



spazzola in polietilene alta densità
polyethylene brush HD



spazzola mista polietilene carlite
mixed brush

EASY WASH 50E

 EASYWASH 50 è dotato di un dispositivo di inclinazione oscillante che permette di lavare con facilità tutte le superfici, anche inclinate.

 EASYWASH 50 is equipped with a tilting facility, therefore the brush always perfectly fit the surface to be cleaned.



spazzola in polietilene alta densità
high density polyethylene brush



 EASYWASH 50 è dotato di un dispositivo di inclinazione oscillante che permette di lavare con facilità tutte le superfici, anche inclinate.

 EASYWASH 50 is equipped with a tilting facility, therefore the brush always perfectly fit the surface to be cleaned.

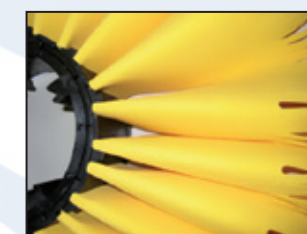

spazzola in carlite autolucidante
self-polishing carlite brush